

# Memory hierarchy

# Processors, cores, memory and PCIe

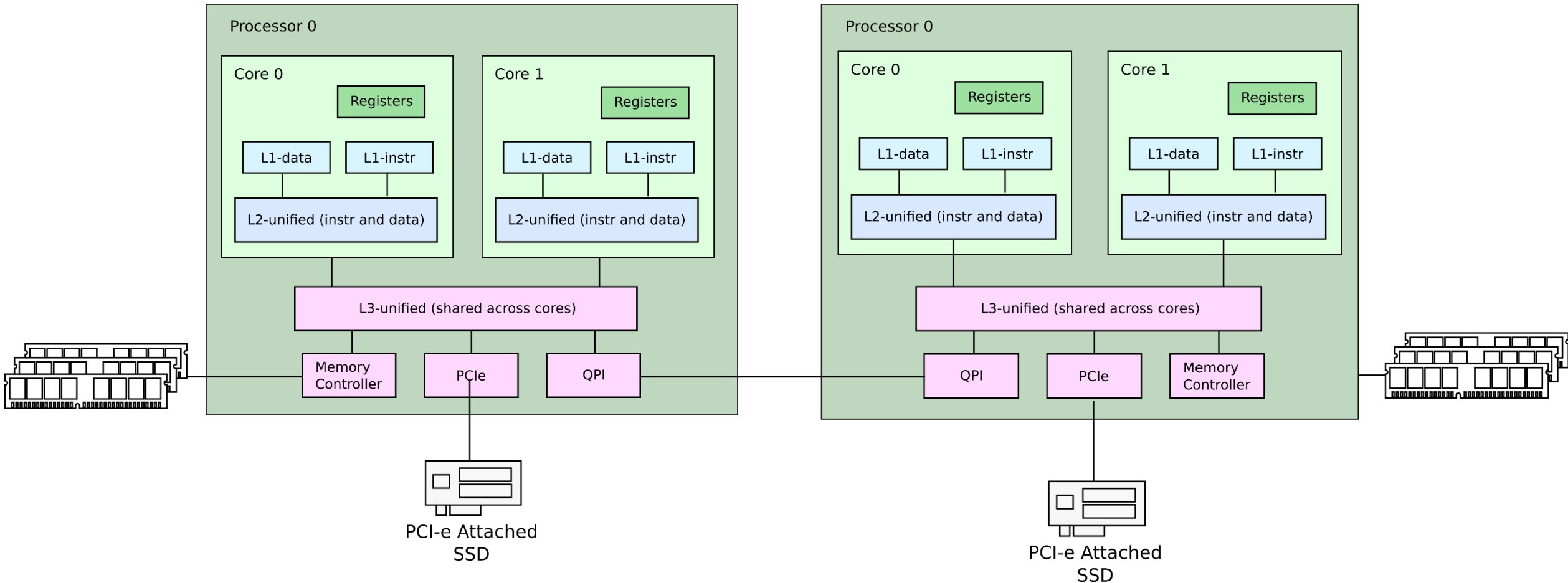

# Caches (load)

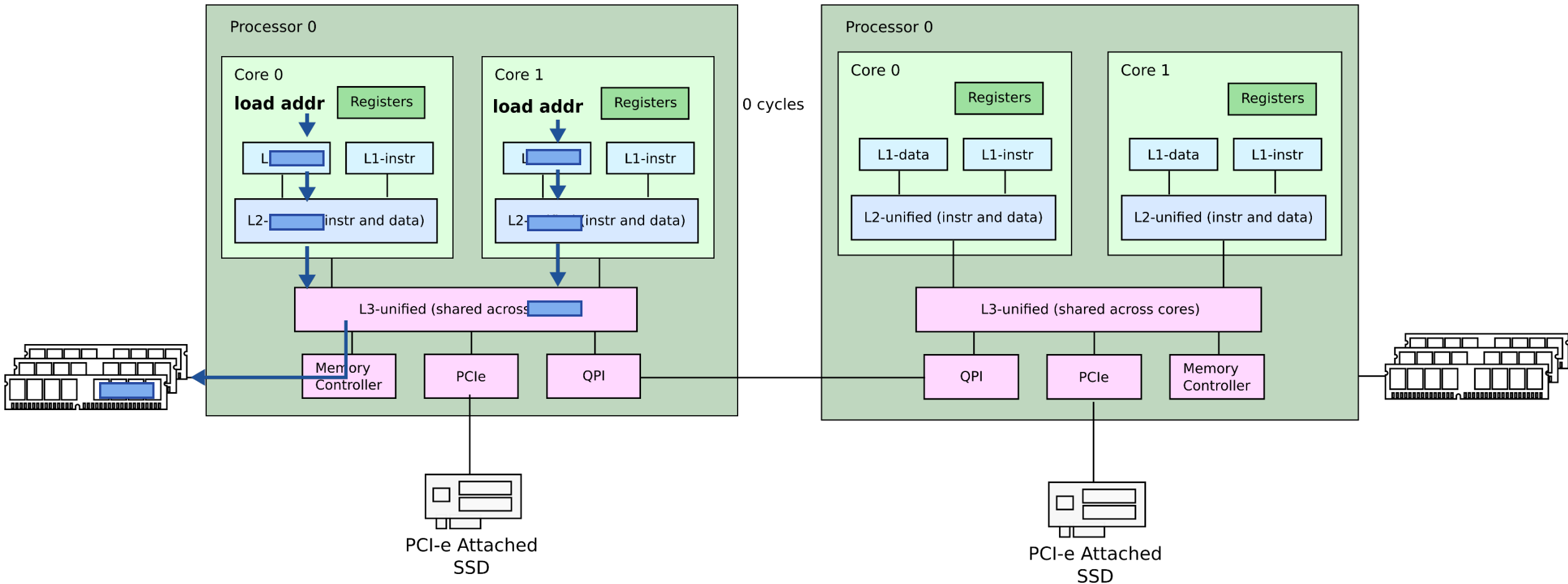

# Cache-coherence (store)

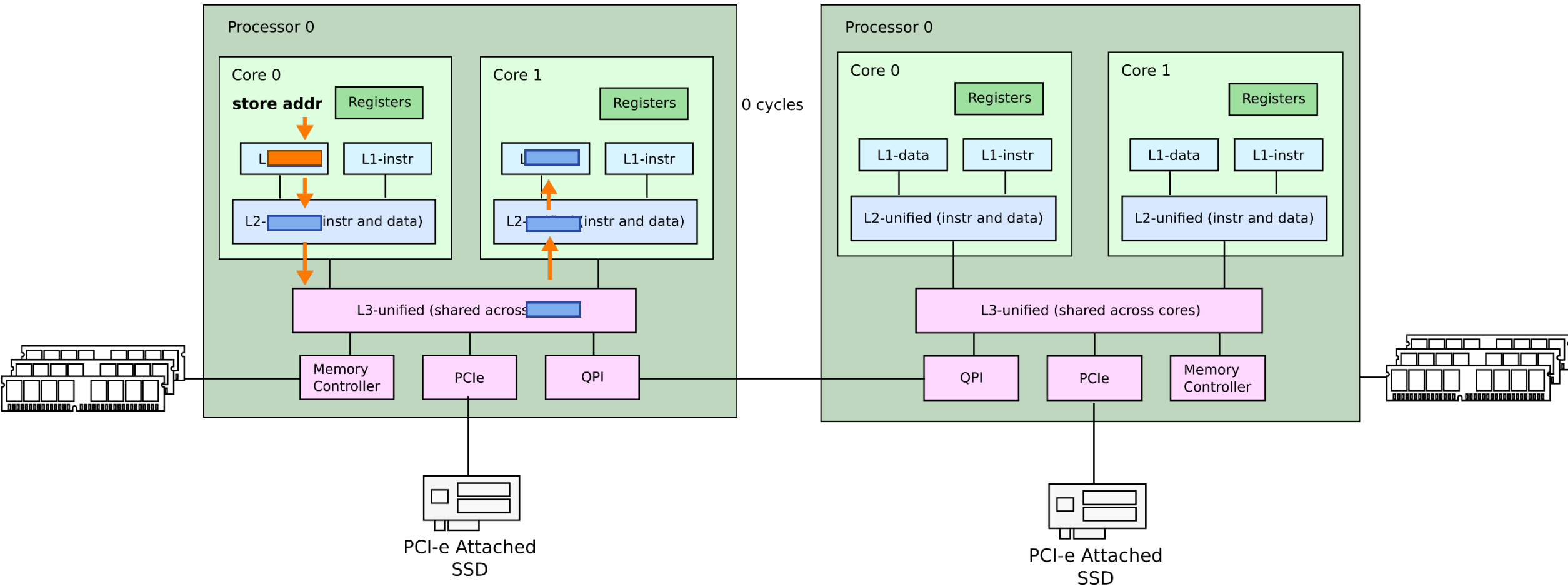

# Cache-coherence (load of modified)

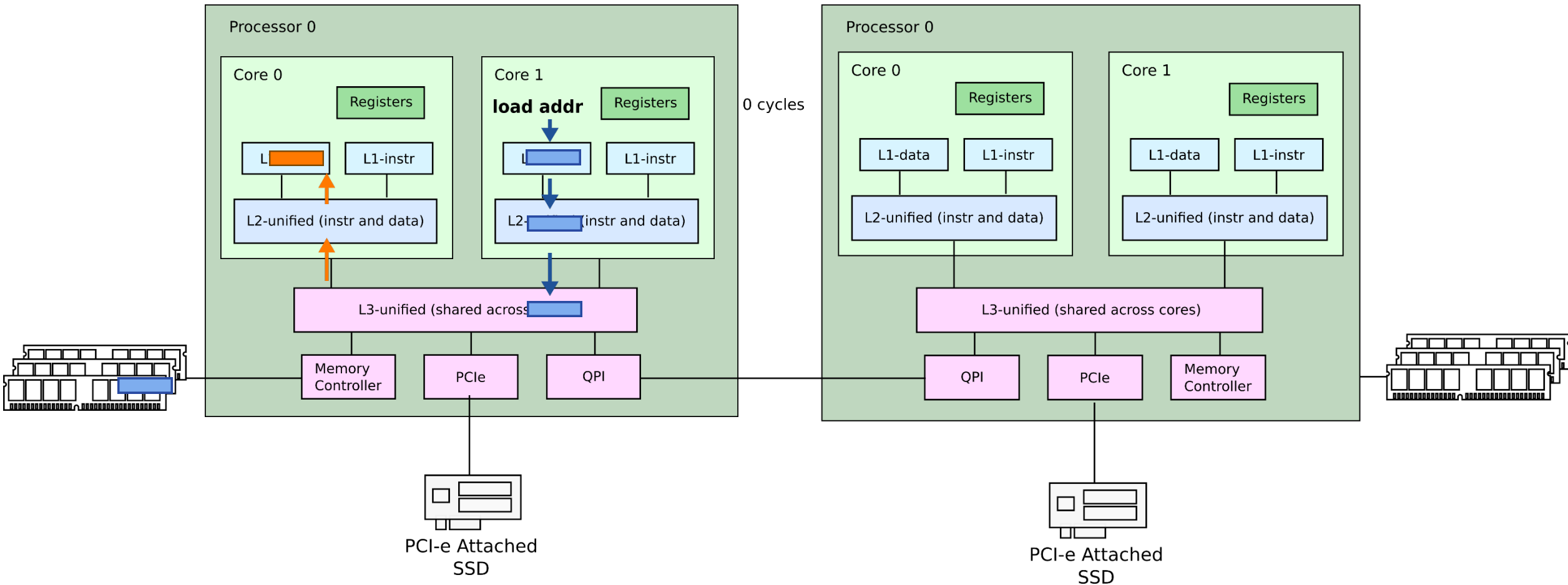

# Latencies: load from local L1

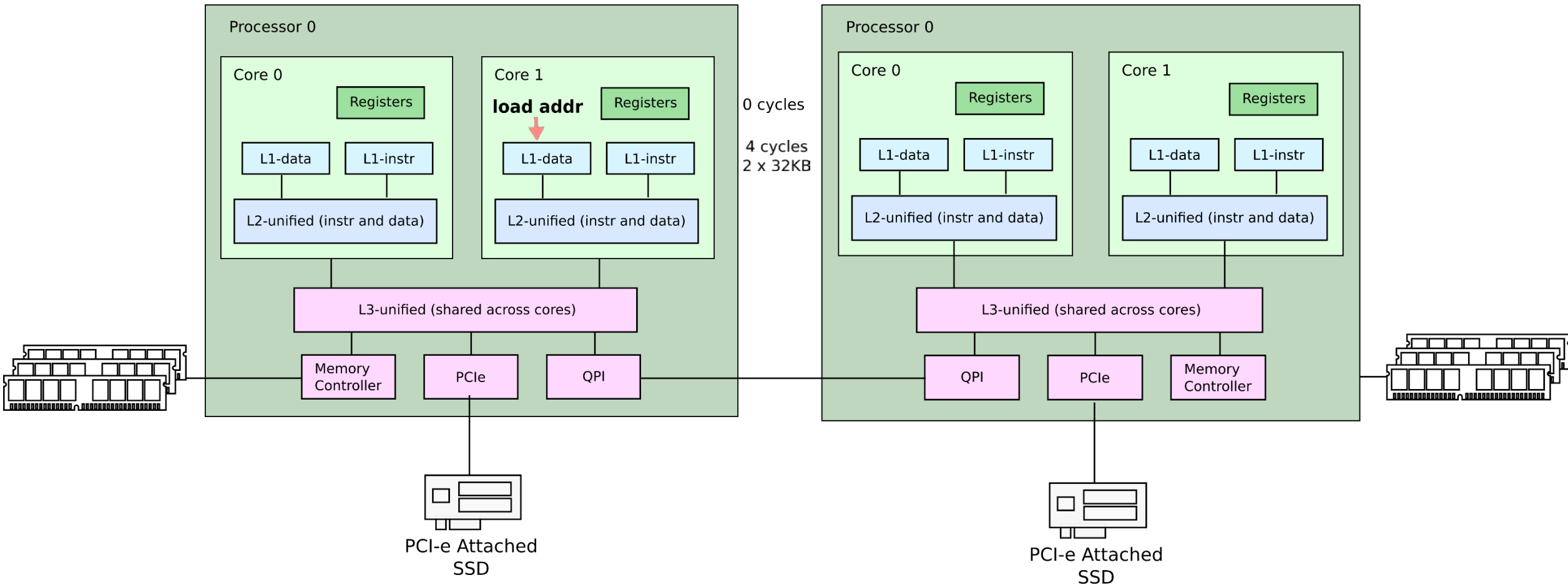

# Latencies: load from local L2

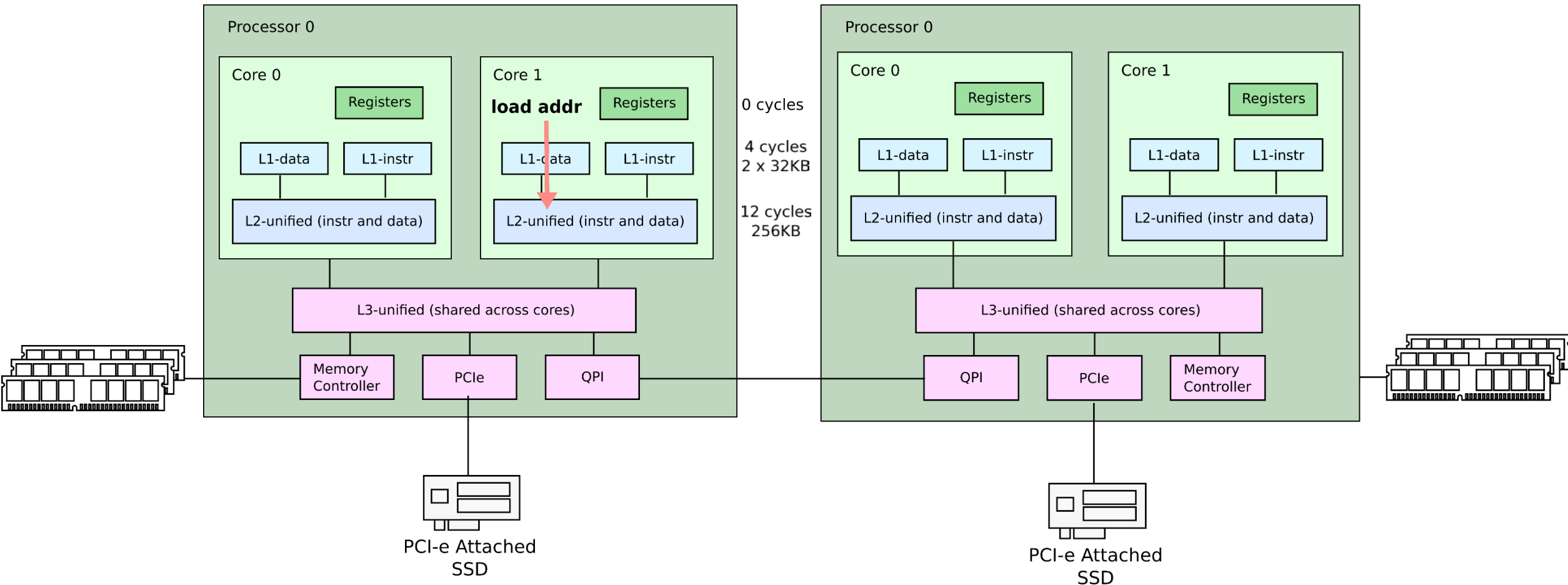

# Latencies: load from local L3

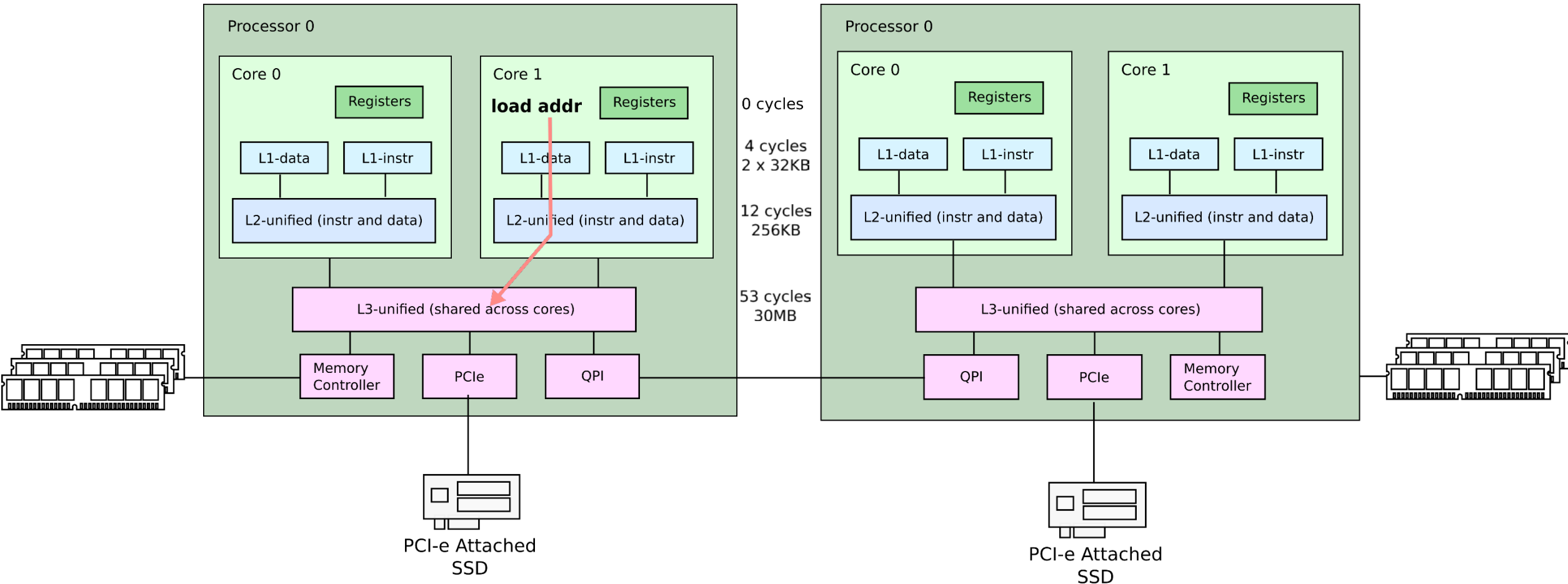



# Latencies: load from local memory

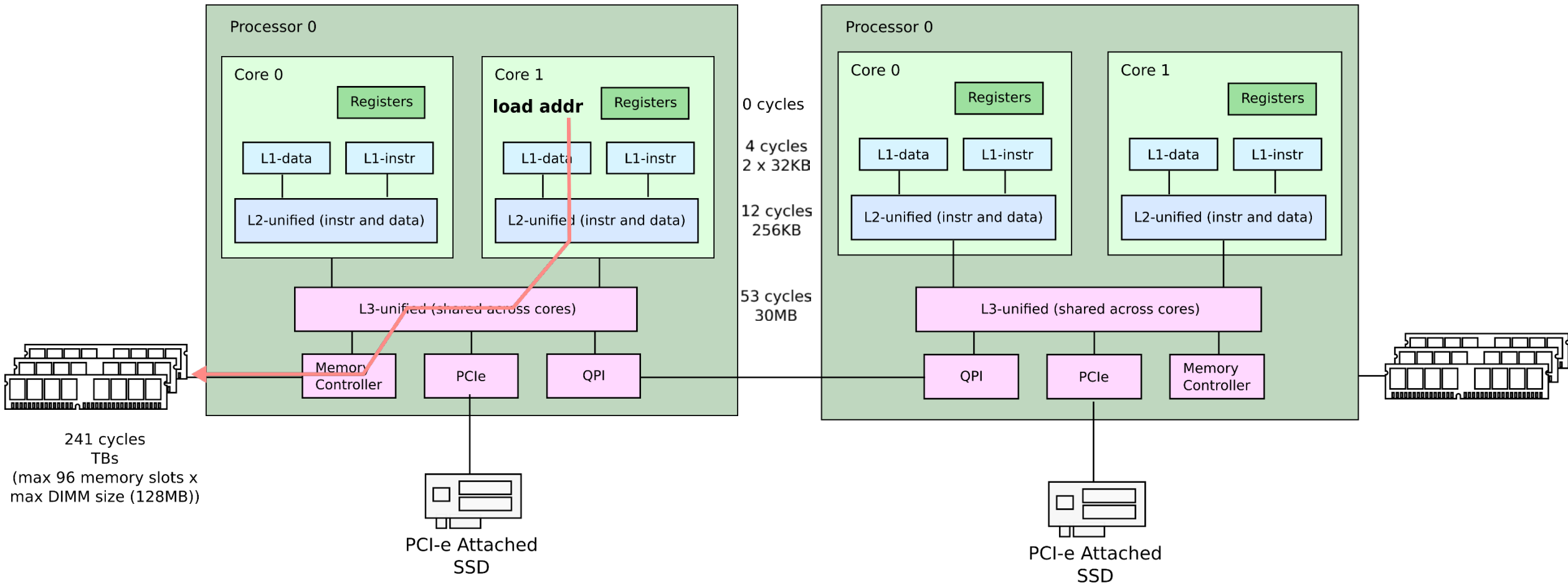

# Latencies: load from same die core's L2

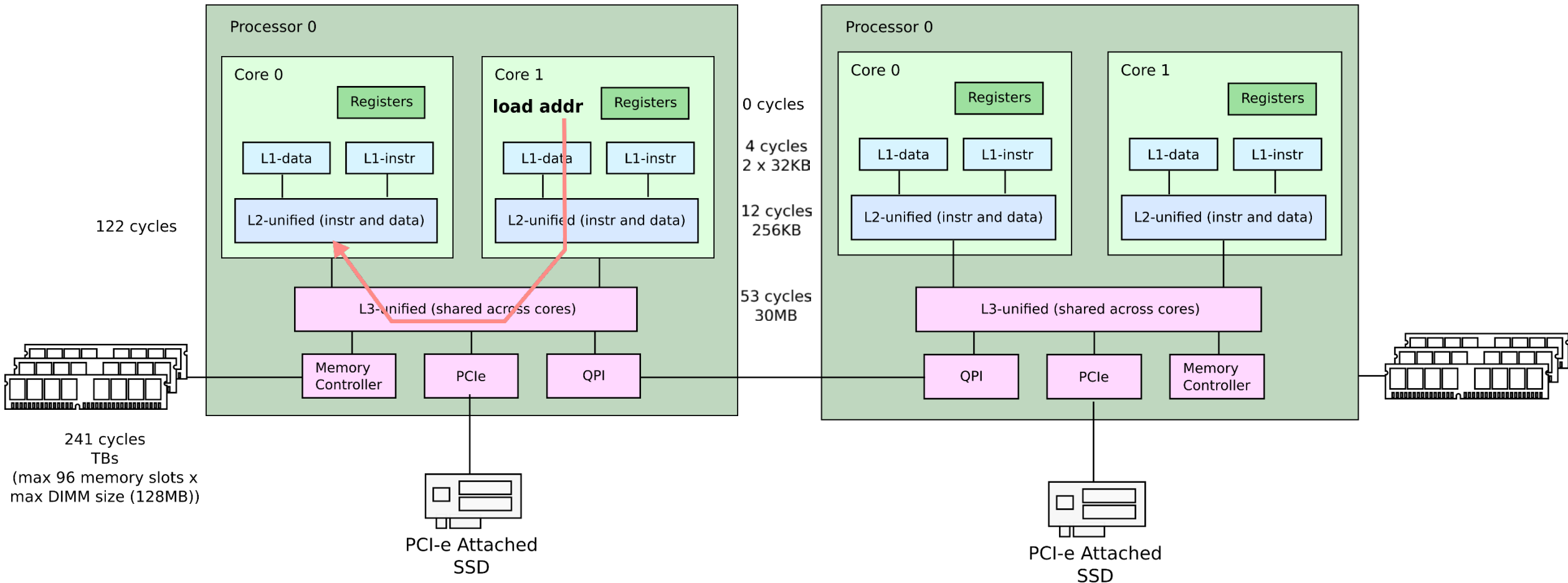

# Latencies: load from same die core's L1

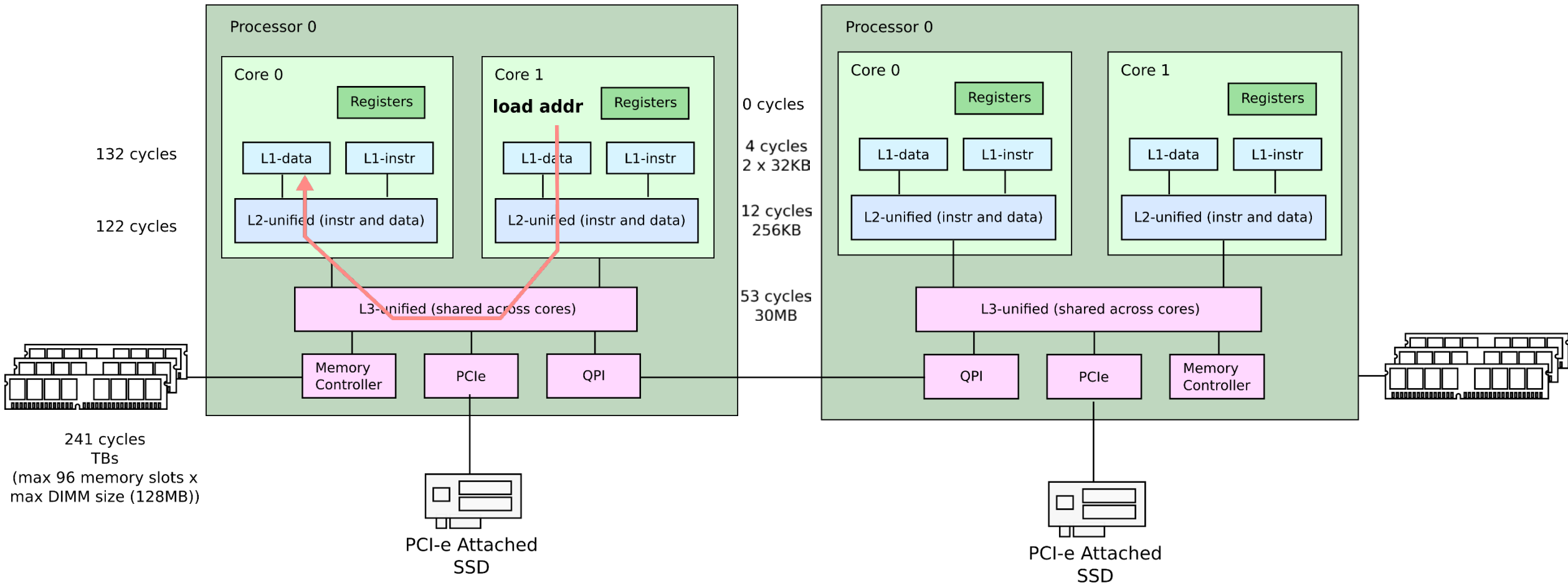

# Latencies: load from remote L3

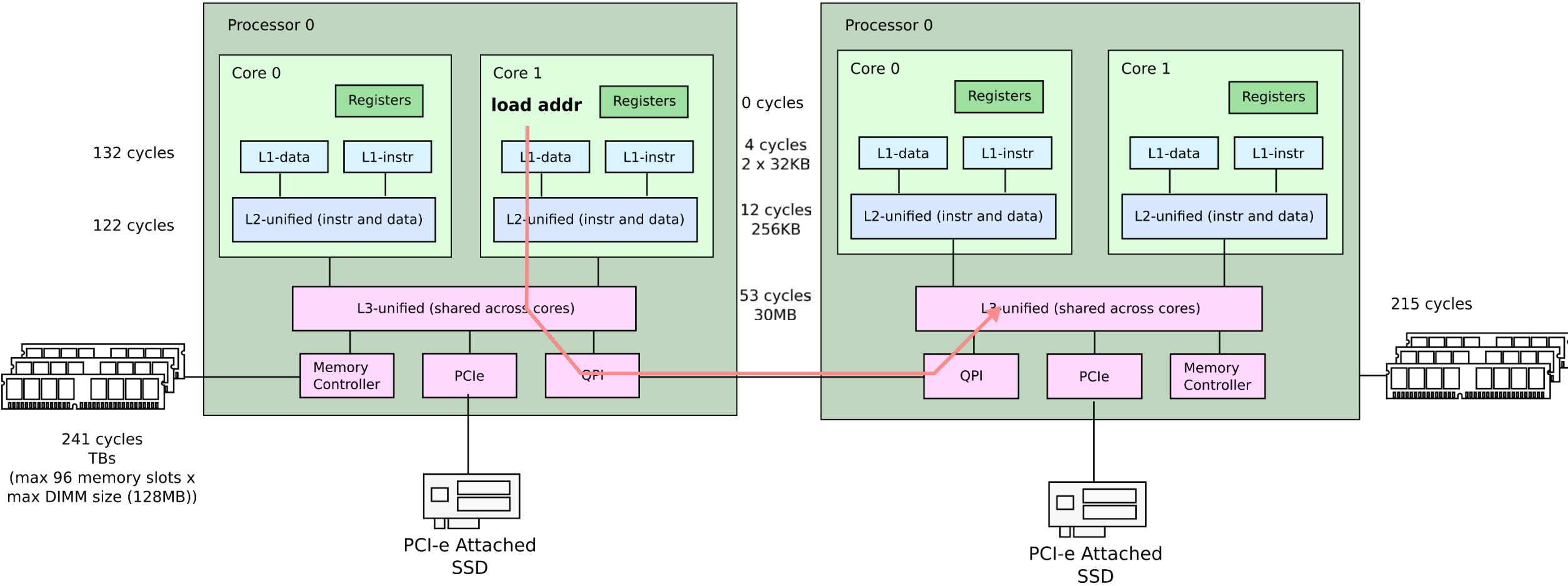



# Latencies: load from remote L2

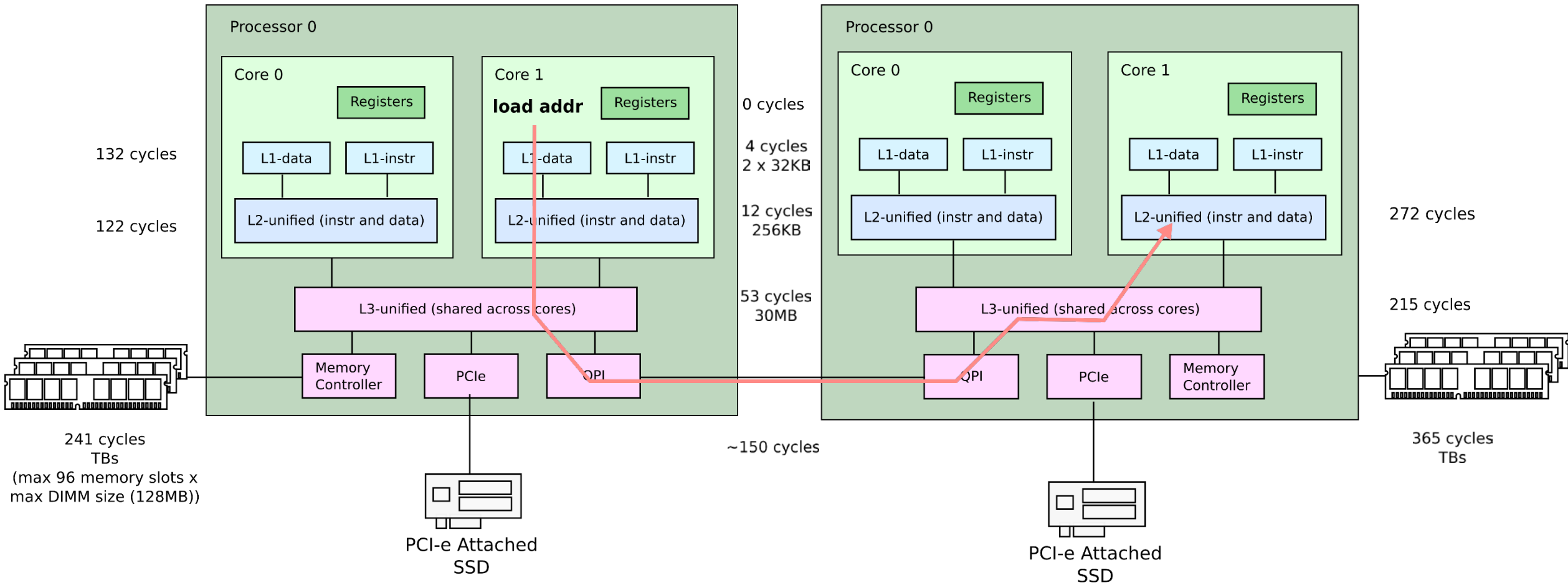

# Latencies: load from remote L2

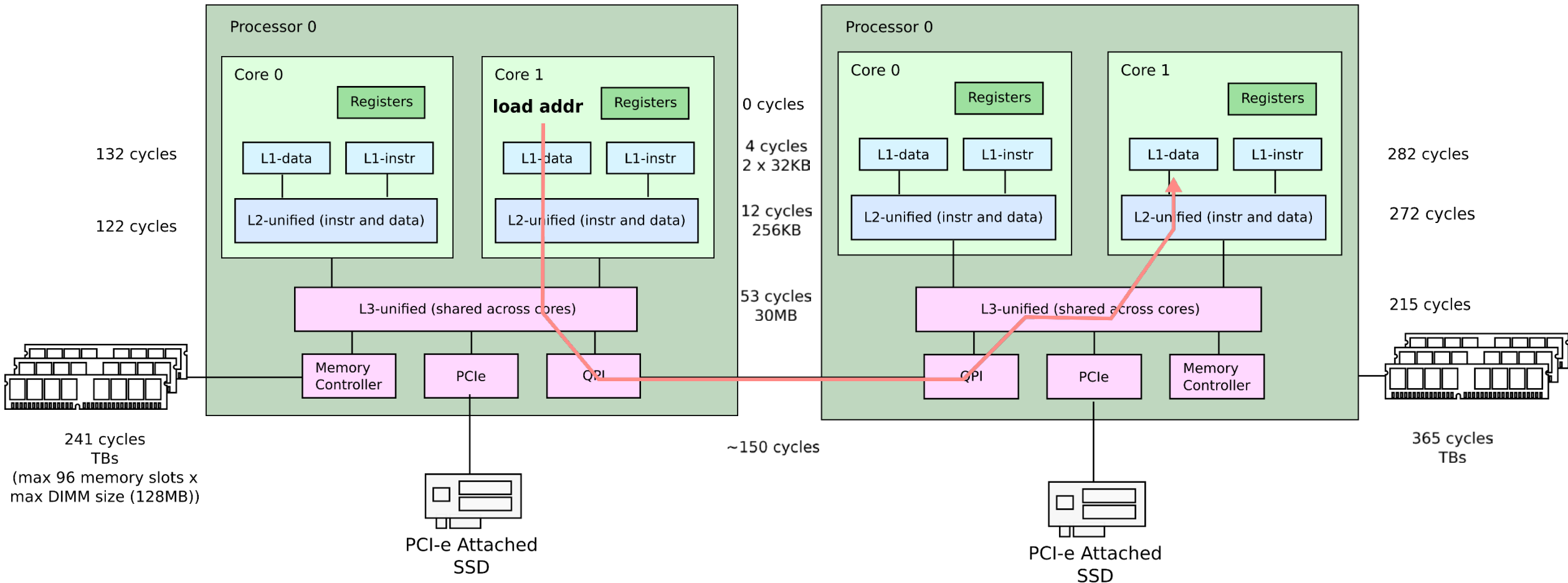

# Latencies: PCIe round-trip

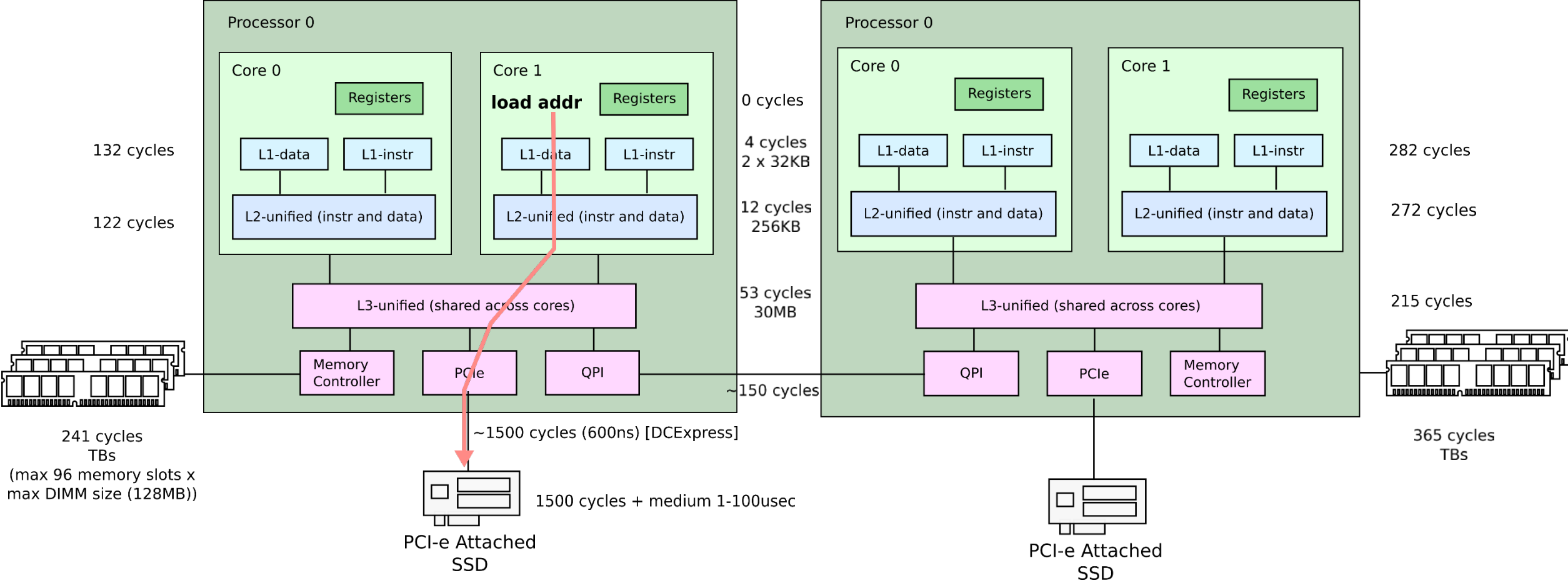



# Device I/O

- Essentially just sending data to and from external devices
- Modern devices communicate over PCIe
  - Well there are other popular buses, e.g., USB, SATA (disks), etc.
  - Conceptually they are similar
- Devices can
  - Read memory
  - Send interrupts to the CPU

# Direct memory access

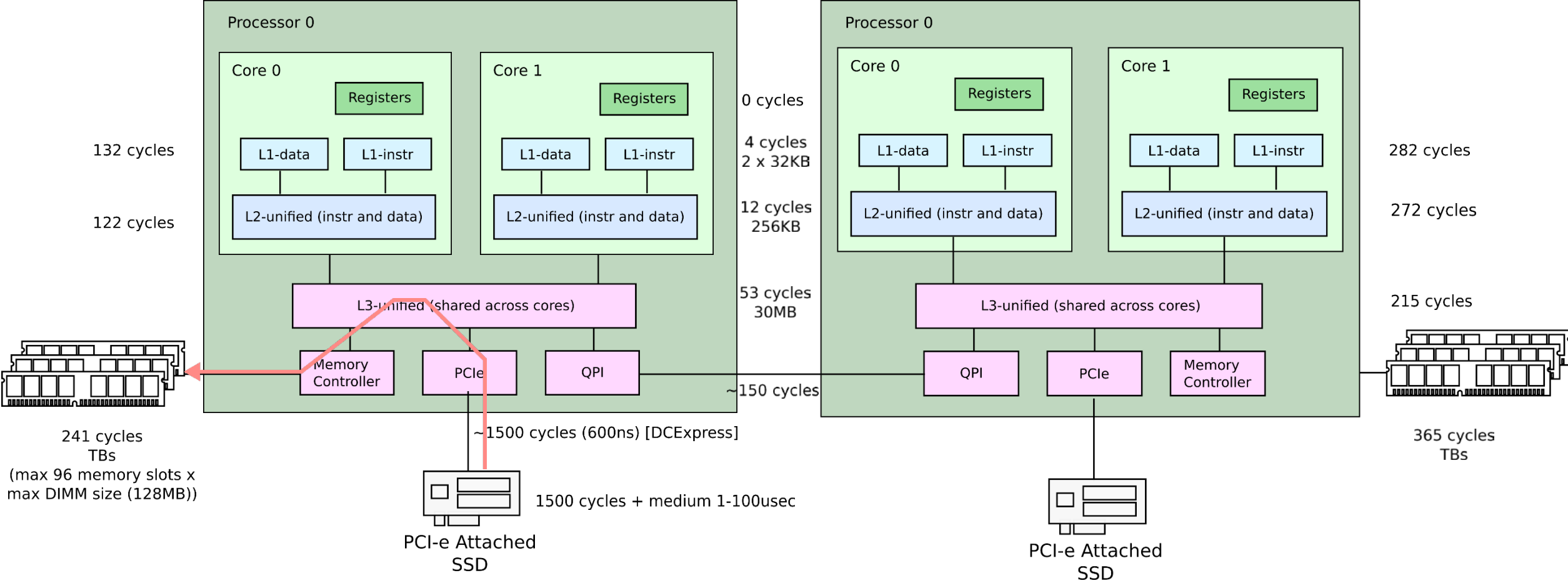

# Interrupts

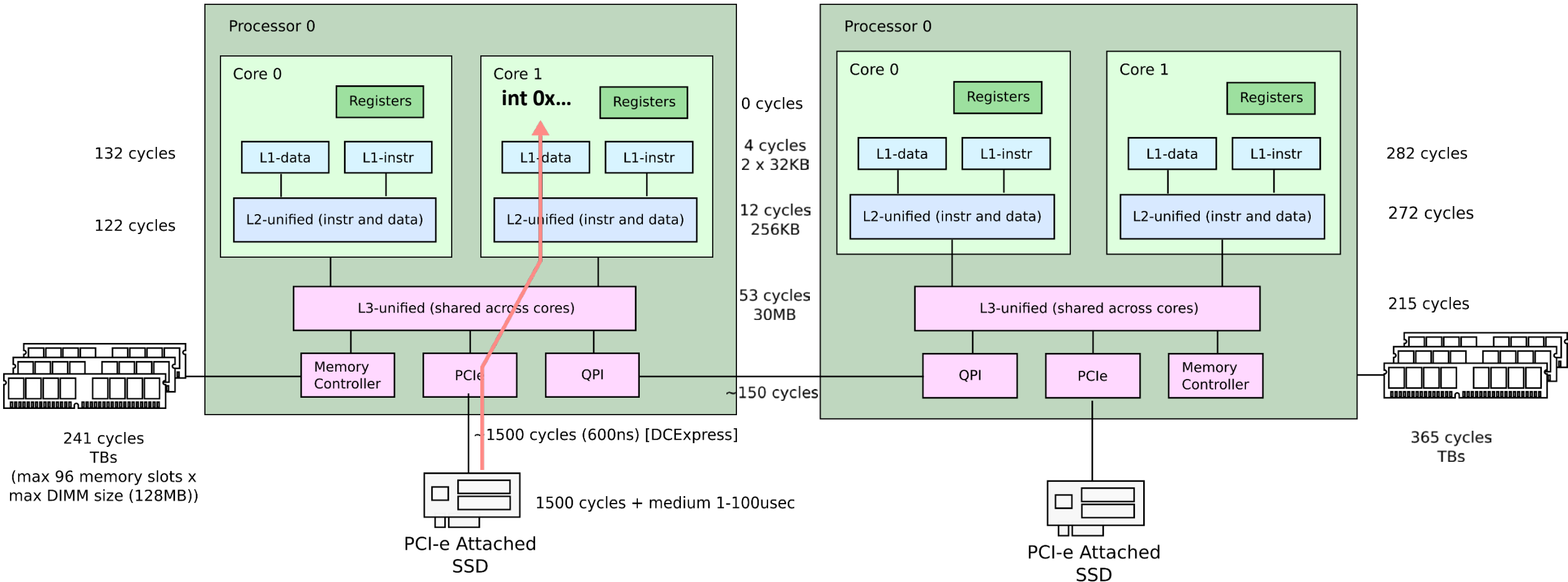

# Device I/O

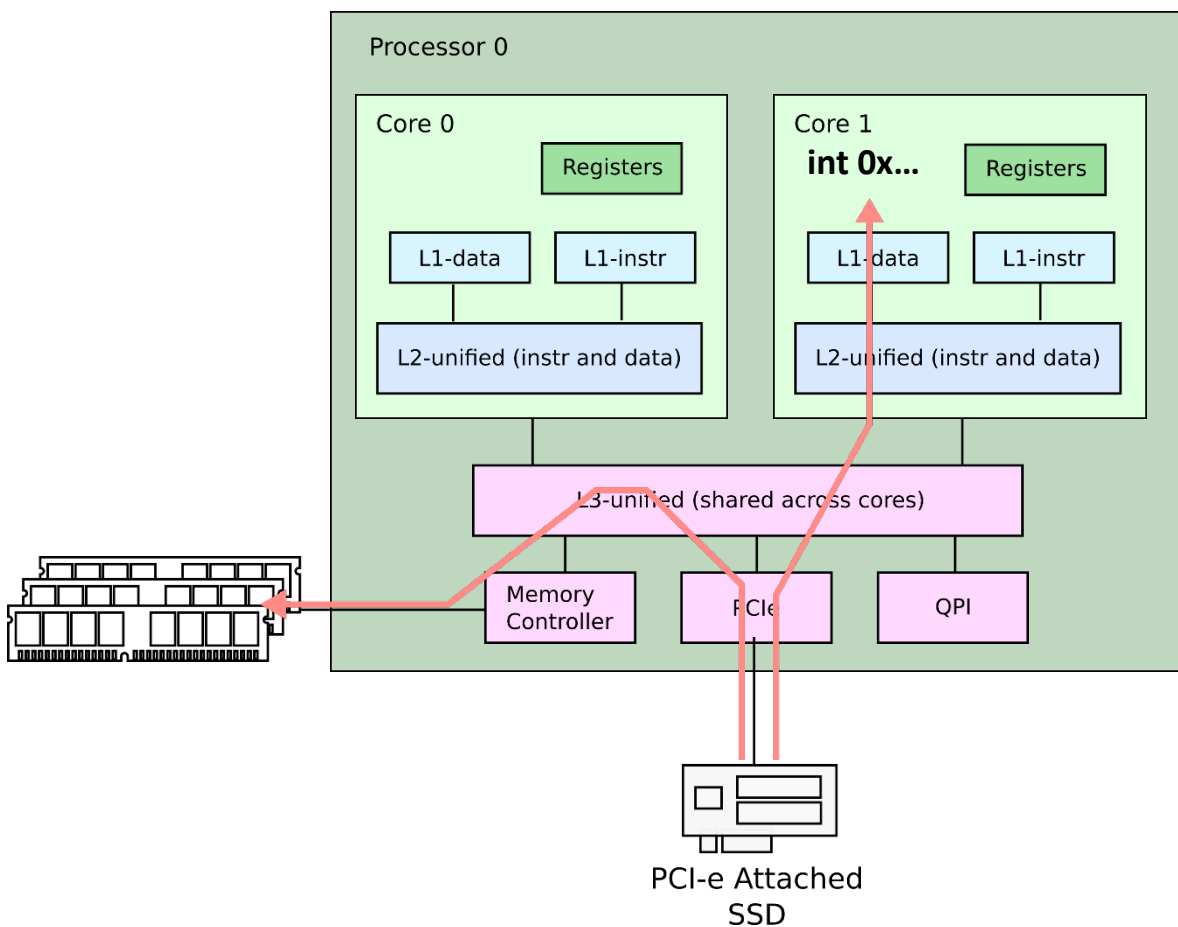

- Write incoming data in memory, e.g.,
  - Network packets
  - Disk requests, etc.
- Then raise an interrupt to notify the CPU
  - CPU starts executing interrupt handler
  - Then reads incoming packets from memory

# Device I/O (polling mode)

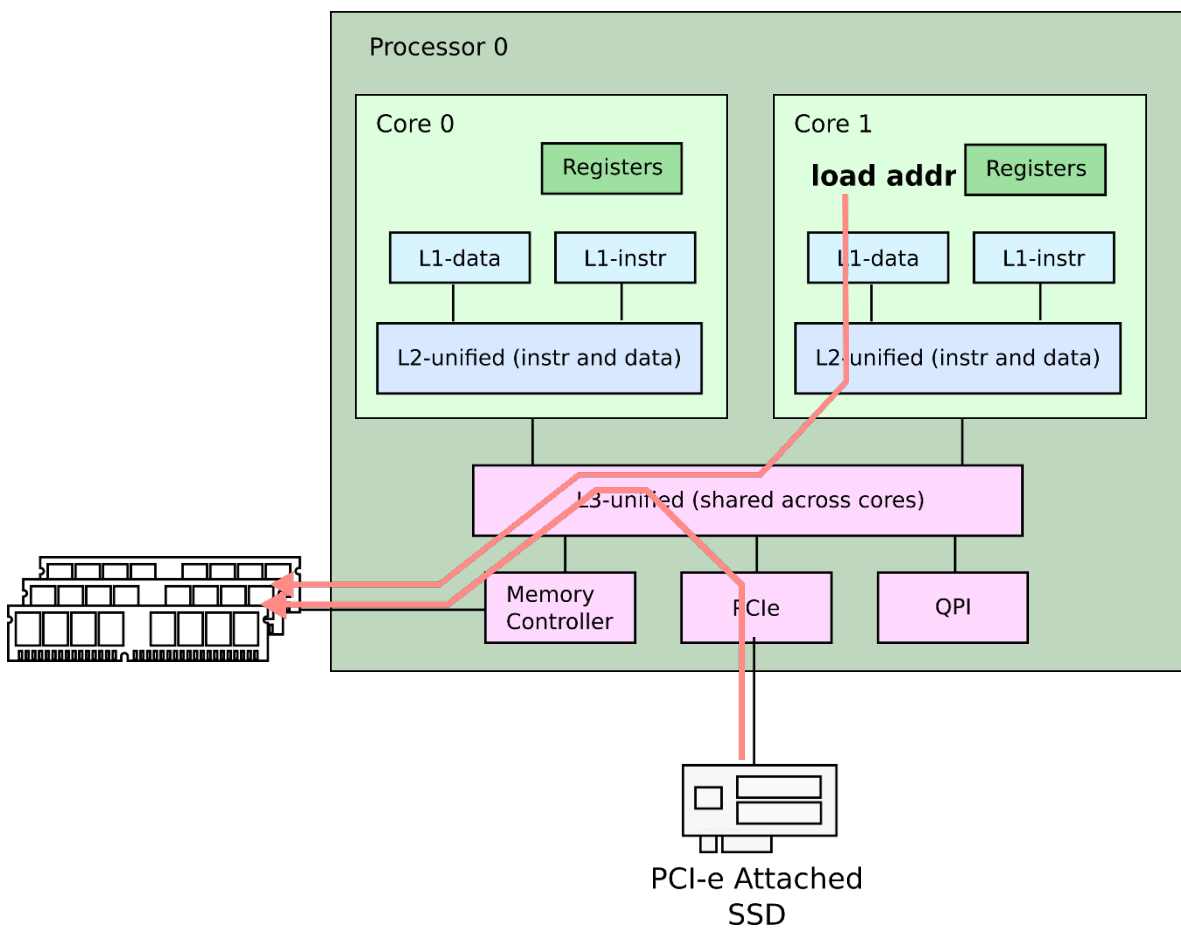

- Alternatively the CPU has to check for incoming data in memory periodically
  - Or poll
- Rationale
  - Interrupts are expensive

# References

- Cache Coherence Protocol and Memory Performance of the Intel Haswell-EP Architecture.  
<http://ieeexplore.ieee.org/abstract/document/7349629>
- Intel SGX Explained <https://eprint.iacr.org/2016/086.pdf>
- DC Express: Shortest Latency Protocol for Reading Phase Change Memory over PCI Express  
[https://www.usenix.org/system/files/conference/fast14/fast14-paper\\_vucinic.pdf](https://www.usenix.org/system/files/conference/fast14/fast14-paper_vucinic.pdf)

Thank you!